

12,8 & 25,6 Volt Lithium-Iron-Phosphate Batteries Smart With Bluetooth

www.victronenergy.com



12,8V 330 Ah LiFePO4 Battery



VictronConnect App

Victron Energy Lithium Battery Smart batteries are Lithium Iron Phosphate (LiFePO₄) batteries and are available in 12.8 V or 25.6 V in various capacities. They can be connected in series, parallel and series/parallel so that a battery bank can be built for system voltages of 12 V, 24 V or 48 V. The maximum number of batteries in one system is 20, which results in a maximum energy storage of 84 kWh in a 12 V system and up to 102 kWh in a 24 V¹⁾ and 48 V¹⁾ system.

A single LFP cell has a nominal voltage of 3.2V. A 12.8 V battery consists of 4 cells connected in series and a 25.6 V battery consists of 8 cells connected in series.

Why lithium-iron-phosphate?

Rugged

A lead-acid battery will fail prematurely due to sulfation:

- If it operates in deficit mode during long periods of time (i.e. if the battery is rarely, or never at all, fully charged).
- If it is left partially charged or worse, fully discharged (yacht or mobile home during wintertime).

A LFP battery:

- Does not need to be fully charged. Service life even slightly improves in case of partial charge instead of a full charge. This is a major advantage of LFP compared to lead-acid.
- Other advantages are the wide operating temperature range, excellent cycling performance, low internal resistance and high efficiency (see below).

LFP is therefore the chemistry of choice for demanding applications.

Efficient

- In several applications (especially off-grid solar and/or wind), energy efficiency can be of crucial importance.
- The round-trip energy efficiency (discharge from 100 % to 0 % and back to 100 % charged) of the average lead-acid battery is 80 %.
- The round-trip energy efficiency of a LFP battery is 92 %.
- The charge process of lead-acid batteries becomes particularly inefficient when the 80 % state of charge has been reached, resulting in efficiencies of 50 % or even less in solar systems where several days of reserve energy is required (battery operating in 70 % to 100 % charged state).
- In contrast, a LFP battery will still achieve 90 % efficiency under shallow discharge conditions.

Size and weight

- Saves up to 70 % in space
- Saves up to 70 % in weight

Expensive?

- LFP batteries are expensive when compared to lead-acid. But in demanding applications, the high initial cost will be more than compensated by longer service life, superior reliability and excellent efficiency.

Bluetooth

- With Bluetooth cell voltages, temperature and alarm status can be monitored.
- Instant readout: The [VictronConnect App](#) can display the most important data on the Device list page without the need to connect to the product.
- Very useful to localize a (potential) problem, such as cell imbalance.

¹⁾To reduce required balancing time, we recommend to use a little different batteries in series as possible for the application. 24 V systems are best built using 24 V batteries. And 48 V systems are best built using two 24 V batteries in series. While the alternative, four 12 V batteries in series, will work, it will require more periodic balancing time.

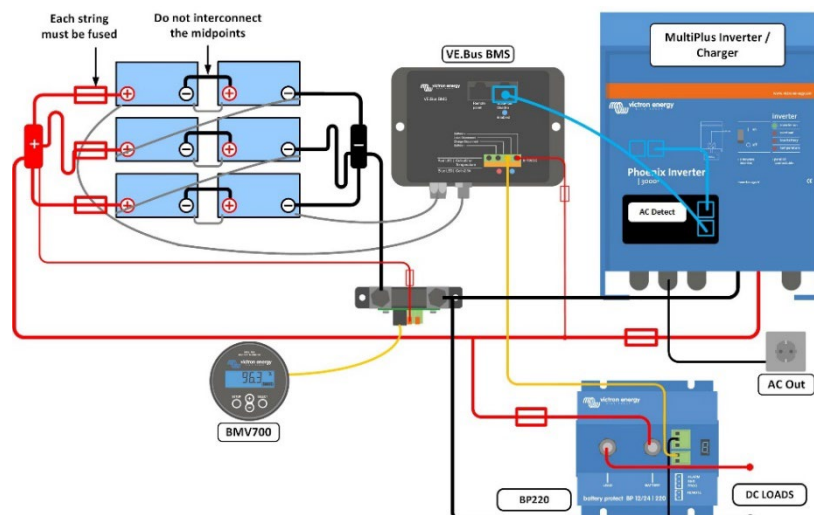

Our LFP batteries have integrated cell balancing and cell monitoring. The cell balancing/monitoring cables can be daisy-chained and must be connected to a Battery Management System (BMS).

Battery Management System (BMS)

The BMS will:

1. Generate a pre-alarm whenever the voltage of a battery cell decreases to less than 3.1 V (adjustable 2.85 V – 3.15 V).
2. Disconnect or shut down the load whenever the voltage of a battery cell decreases to less than 2.8 V (adjustable 2.6 V – 2.8 V).
3. Stop the charging process whenever the voltage of a battery cell increases to more than 3.75 V or when the temperature becomes too high or too low.

See the BMS datasheets for more features.

Battery specification								
VOLTAGE AND CAPACITY	LFP-Smart 12,8/50	LFP-Smart 12,8/100	LFP-Smart 12,8/160	LFP-Smart 12,8/180	LFP-Smart 12,8/200	LFP-Smart 12,8/330	LFP-Smart 25,6/100	LFP-Smart 25,6/200-a
Nominal voltage	12,8 V	12,8 V	12,8 V	12,8 V	12,8 V	12,8 V	25,6 V	25,6 V
Nominal capacity @ 25°C*	50 Ah	100 Ah	160 Ah	180 Ah	200 Ah	330 Ah	100 Ah	200 Ah
Nominal capacity @ 0°C*	40 Ah	80 Ah	130 Ah	150 Ah	160 Ah	260 Ah	80 Ah	160 Ah
Nominal capacity @ -20°C*	25 Ah	50 Ah	80 Ah	90 Ah	100 Ah	160 Ah	50 Ah	100 Ah
Nominal energy @ 25°C*	640 Wh	1280 Wh	2048 Wh	2304 Wh	2560 Wh	4220 Wh	2560 Wh	5120 Wh
*Discharge current ≤1C								
CYCLE LIFE (capacity ≥ 80 % of nominal)								
80 % DoD	2500 cycles							
70 % DoD	3000 cycles							
50 % DoD	5000 cycles							
DISCHARGE								
Maximum continuous discharge current	100 A	200 A	320 A	360 A	400 A	400 A	200 A	400 A
Recommended continuous discharge current	≤50 A	≤100 A	≤160 A	≤180 A	≤200 A	≤300 A	≤100 A	≤200 A
End of discharge voltage	11,2 V	11,2 V	11,2 V	11,2 V	11,2 V	11,2 V	22,4 V	22,4 V
Internal resistance	2mΩ	0,8mΩ	0,9mΩ	0,9mΩ	0,8mΩ	0,8mΩ	1,6mΩ	1,5mΩ
OPERATING CONDITIONS								
Operating temperature	Discharge: -20°C to +50°C Charge: +5°C to +50°C							
Storage temperature	-45°C to +70°C							
Humidity (non-condensing)	Max. 95 %							
Protection class	IP 22							
CHARGE								
Charge voltage	Between 14 V/28 V and 14,4 V/28,8 V (14,2 V/28,4 V recommended)							
Float voltage	13,5 V/27 V							
Maximum charge current	100 A	200 A	320 A	360 A	400 A	400 A	200 A	400 A
Recommended charge current	≤30 A	≤50 A	≤80 A	≤90 A	≤100 A	≤150 A	≤50 A	≤100 A
OTHER								
Max storage time @ 25°C*	1 year							
BMS connection	Male + female cable with M8 circular connector, length 50cm							
Power connection (threaded inserts)	M8	M8	M8	M8	M8	M10	M8	M8
Dimensions (hxxwxd) mm	199 x 188 x 147	197 x 321 x 152	237 x 321 x 152	237 x 321 x 152	237 x 321 x 152	265 x 359 x 206	197 x 650 x 163	237 x 650 x 163
Weight	7 kg	14 kg	18 kg	18 kg	20 kg	29 kg	28 kg	39 kg
* When fully charged								